

Profili di bordo e per angoli

Tipo L 407

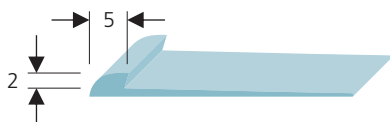

Tipo L 406

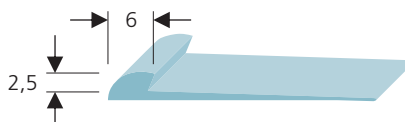

Tipo L 405



Tipo L 402

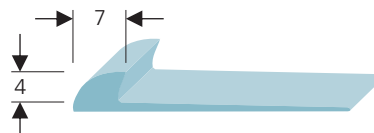

Tipo L 404

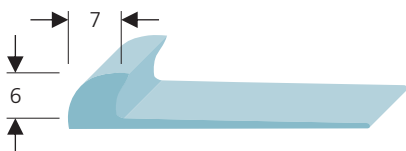

Tipo L 409

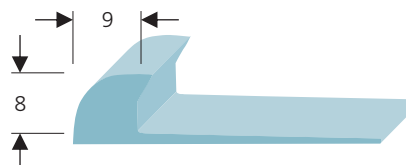

Tipo L 417



Tipo L 423

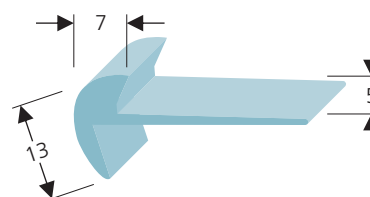

Tipo L 424
per soglie

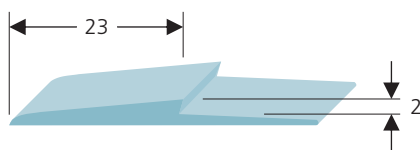

Tipo L 428
per soglie

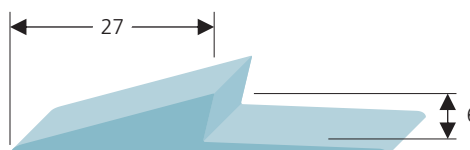

Profili di bordo e per angoli

Tipo L 412

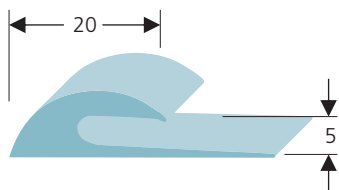

Tipo L 429

Cuneo

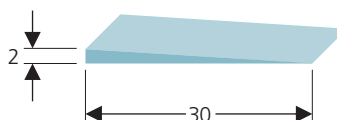

Tipo L 418

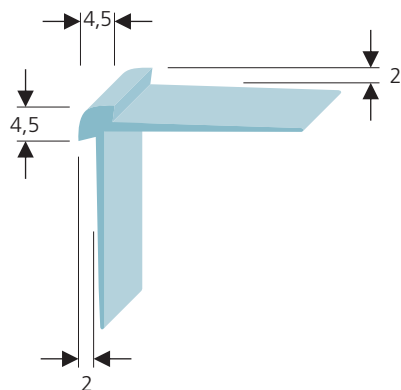

Tipo L 425

Chiusura per binari di tende

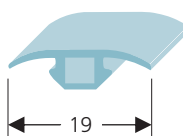

Tipo L 300

Profilo d'angolo

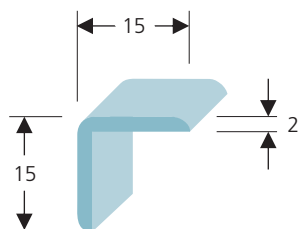

Tipo L 301

Profilo d'angolo

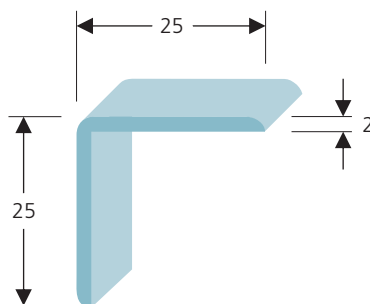

Tipo L 308

Profilo d'angolo,
abbinabile a TW 802/902

