

## Abschlussprofile, Winkelprofile

Typ L 407

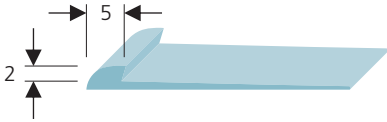

Typ L 406

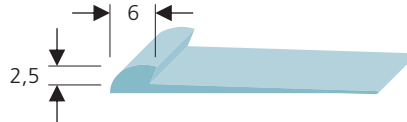

Typ L 405

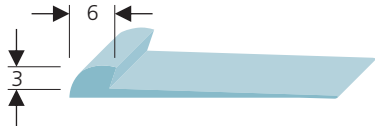

Typ L 402

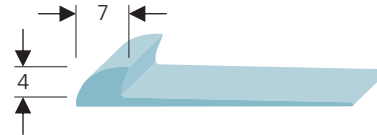

Typ L 404

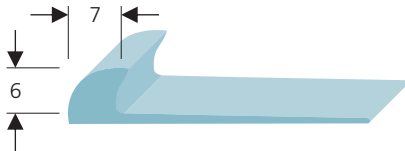

Typ L 409

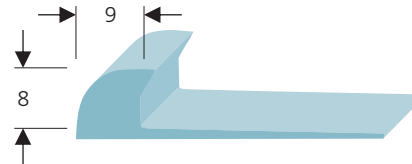

Typ L 417



Typ L 423

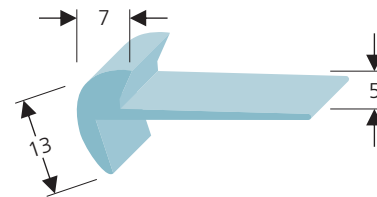

Typ L 424  
Für Schmutzschleusen

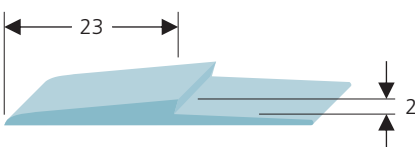

Typ L 428  
Für Schmutzschleusen

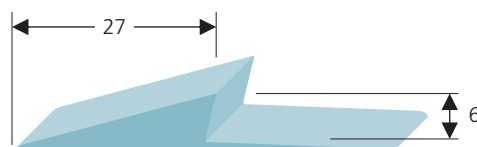

## Abschlussprofile, Winkelprofile

**Typ L 412**

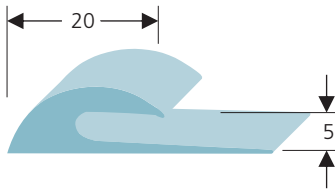

**Typ L 429**  
Keilprofil

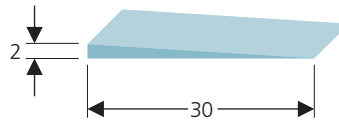

**Typ L 418**

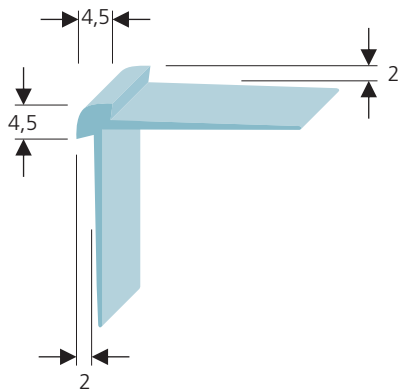

**Typ L 425**  
Abdeckprofil für Vorhangschienen

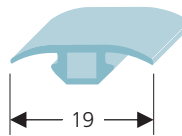

**Typ L 300**  
Winkelprofil

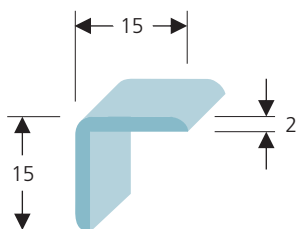

**Typ L 301**  
Winkelprofil

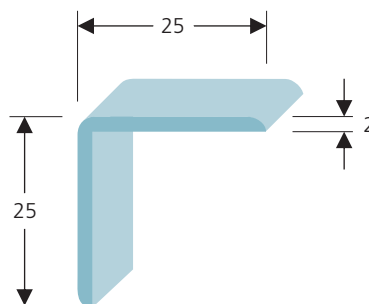

**Typ L 308**  
Winkelprofil,  
passend zu TW 802/902

